

Montageanleitung

Ⓒ mounting instruction Ⓕ Notice de montage Ⓖ Instrukcja montażu
Ⓔ Instrucciones de montaje Ⓘ Istruzioni di montaggio

STORA-P

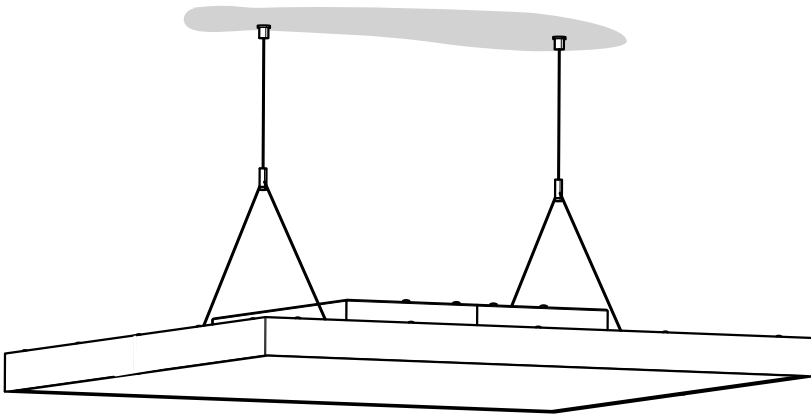

RIDI Leuchten GmbH
Hauptstrasse 31 - 33 · D-72417 Jungingen
Tel. 07477/872-0 · Fax 07477/872-48
kontakt@ridi-group.de · www.ridi-group.com



D Für die Installation und für den Betrieb der Leuchten sind die nationalen Sicherheitsvorschriften zu beachten.

GB Please note national safety instructions for installation and operation of this luminaire.

F Pour l'installation et le fonctionnement des luminaires il est impératif de respecter les normes nationales de sécurité en vigueur.

PL W celu prawidłowej instalacji i poprawnego działania oprawy należy przestrzegać krajowych przepisów bezpieczeństwa.

E Para la instalación y la puesta en funcionamiento de las luminarias deben observarse las normas nacionales de seguridad.

I Per l'installazione e il funzionamento delle lampade si fa riferimento alle normative di sicurezza nazionali.

D Die Lichtquelle dieser Leuchte darf nur vom Hersteller oder einem von ihm beauftragten Servicetechniker oder einer vergleichbar qualifizierten Person ersetzt werden.

GB Only the manufacturer, an instructed service technician or another equally qualified person is allowed to replace the light source of this luminaire.

F La source lumineuse de ce luminaire ne peut être remplacée que par le fabricant, un technicien de service mandaté par celui-ci ou une personne présentant une qualification analogue.

PL Wymiany źródła światła oprawy oświetleniowej może dokonać wyłącznie producent lub uprawniony pracownik serwisu lub osoba o podobnych kwalifikacjach.

E La fuente de luz de esta luminaria solamente podrá ser sustituida por el fabricante o una persona designada por este, ya sea un técnico de servicio u otra persona debidamente cualificada.

I La sorgente luminosa di tale lampada può essere sostituita solo dal produttore o da un tecnico di assistenza da questi designato oppure da personale dotato di qualifica equivalente.

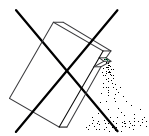
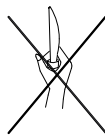
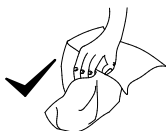
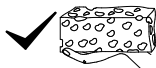
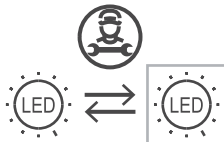
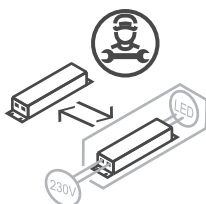
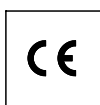
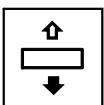
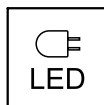

Druckfehler und Irrtum vorbehalten. Formelle und technische Änderungen behalten wir uns vor.
Misprints and errors excepted. We reserve the right of formal and technical modifications.

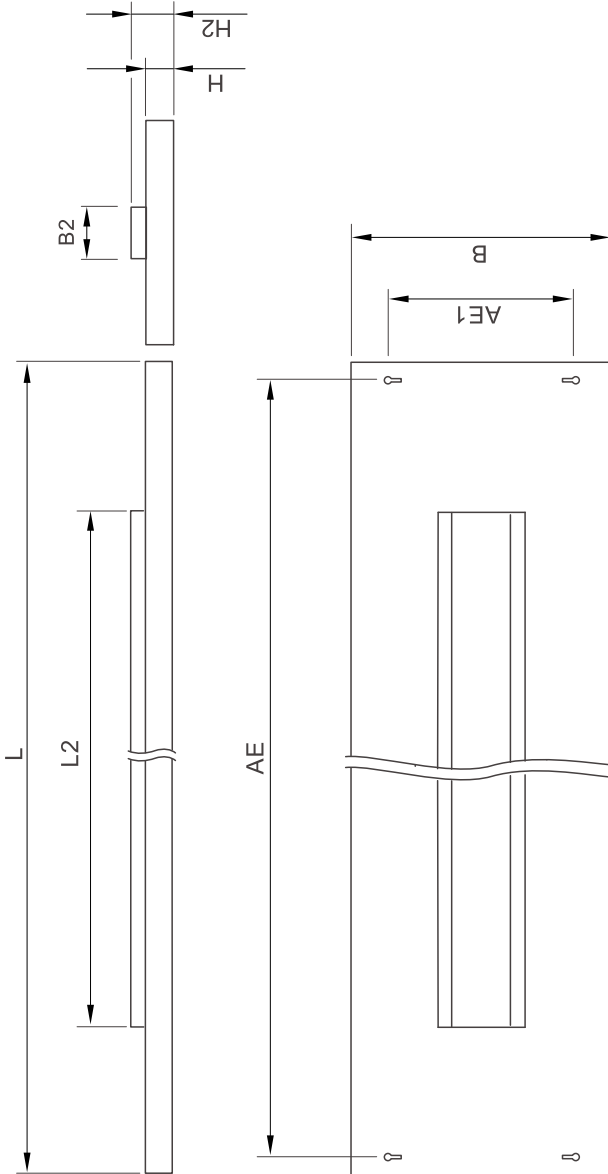
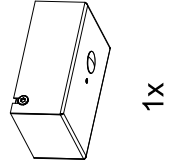
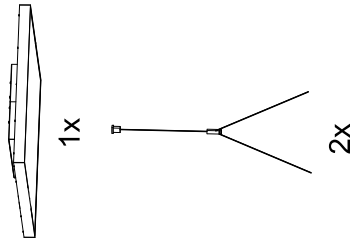
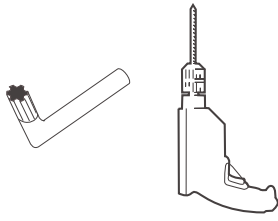

Type	L	B	AE	AE1	L2	B2	H	H2	366	368	890	1660
STORA-QP 5200	580	580	500	230	483	126	50	74,5	366	368	890	1660
STORA-P 5200	1070	330	1040	130	830	48	50	74,5	366	368	890	1660
STORA-P 7800	1565	330	1535	130	830	48	50	74,5	366	368	890	1660
STORA-P 800X800	800	800	430	412	380	380	50	91,75	366	368	890	1660

