

Montageanleitung

Ⓒ mounting instruction Ⓕ Notice de montage Ⓒ Instrukcja montażu
Ⓔ Instrucciones de montaje Ⓘ Istruzioni di montaggio

EBRE-LED ... EBRME-LED ... H=60

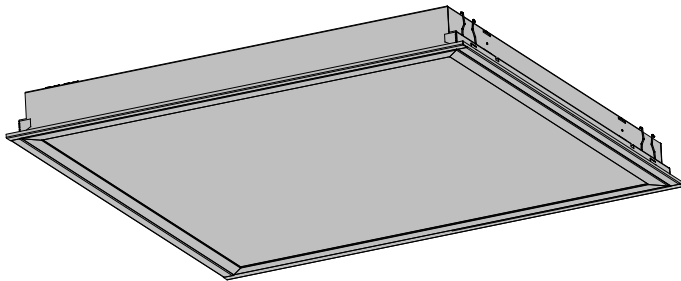

RIDI Leuchten GmbH
Hauptstrasse 31 - 33 · D-72417 Jungingen
Tel. 07477/872-0 · Fax 07477/872-48
kontakt@ridi-group.de · www.ridi-group.com



- (D) Für die Installation und für den Betrieb der Leuchten sind die nationalen Sicherheitsvorschriften zu beachten.
- (GB) Please note national safety instructions for installation and operation of this luminaire.
- (F) Pour l'installation et le fonctionnement des luminaires il est impératif de respecter les normes nationales de sécurité en vigueur.
- (PL) W celu prawidłowej instalacji i poprawnego działania oprawy należy przestrzegać krajowych przepisów bezpieczeństwa.
- (E) Para la instalación y la puesta en funcionamiento de las luminarias deben observarse las normas nacionales de seguridad.
- (I) Per l'installazione e il funzionamento delle lampade si fa riferimento alle normative di sicurezza nazionali.

- (D) Die Lichtquelle dieser Leuchte darf nur vom Hersteller oder einem von ihm beauftragten Servicetechniker oder einer vergleichbar qualifizierten Person ersetzt werden.
- (GB) Only the manufacturer, a trained service technician or another equally qualified person is permitted to replace the light source of this luminaire.
- (F) La source lumineuse de ce luminaire ne peut être remplacée que par le fabricant, un technicien de service mandaté par celui-ci ou une personne présentant une qualification analogue.
- (PL) Wymiany źródła światła w tej oprawie oświetleniowej może dokonać wyłącznie producent bądź uprawniony pracownik serwisu albo osoba o podobnych kwalifikacjach.
- (E) La fuente de luz de esta luminaria solamente podrá ser sustituida por el fabricante o una persona designada por este, ya sea un técnico de servicio u otra persona debidamente cualificada.
- (I) La sorgente luminosa di tale lampada può essere sostituita solo dal produttore o da un tecnico di assistenza da questi designato oppure da personale dotato di qualifica equivalente.

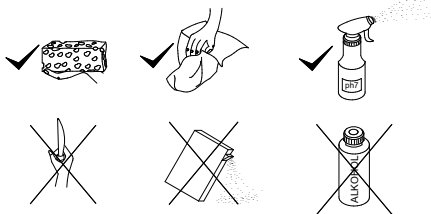
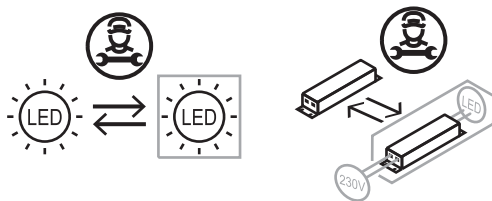

Druckfehler und Irrtum vorbehalten.
Formelle und technische Änderungen behalten wir uns vor.

Misprints and errors excepted.
We reserve the right of formal and technical modifications.

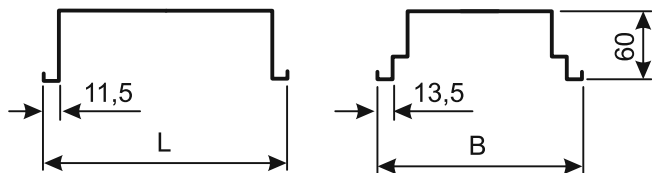

TYP	L	B	L _E	B _E	L _S	B _S
EBRE-LED 228 ...	1247	310	1229	292	1250	312,5
EBRE-LED 414 ...	622	622	604	604	625	625
EBRME-LED 228 ...	1197	297	1179	279	1200	300
EBRME-LED 414 ...	597	597	579	579	600	600

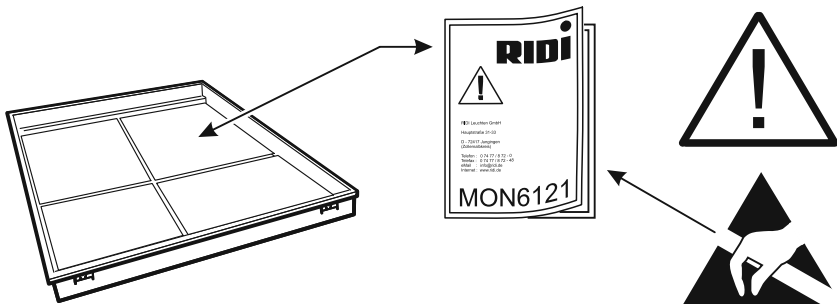
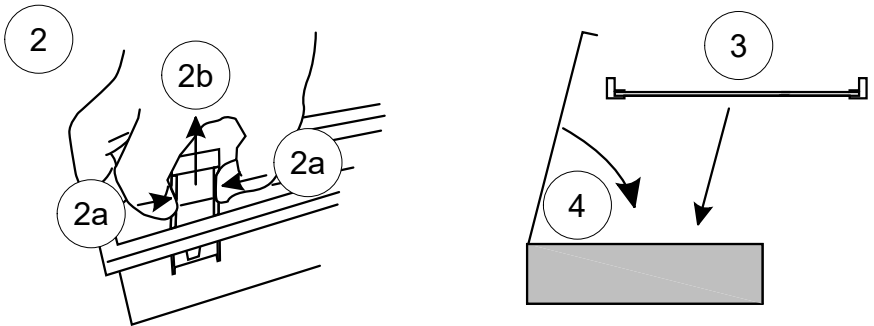
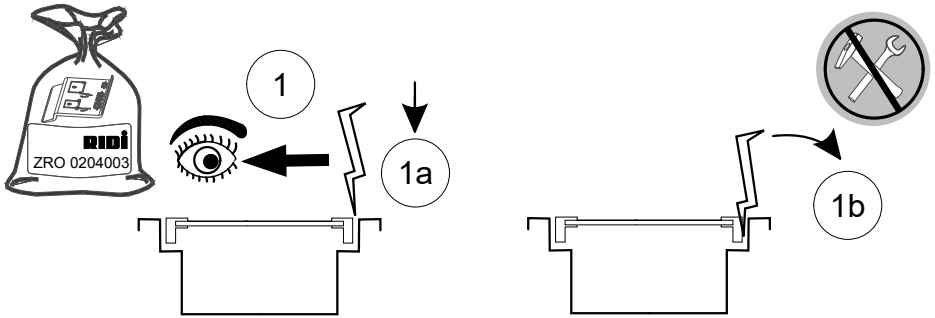
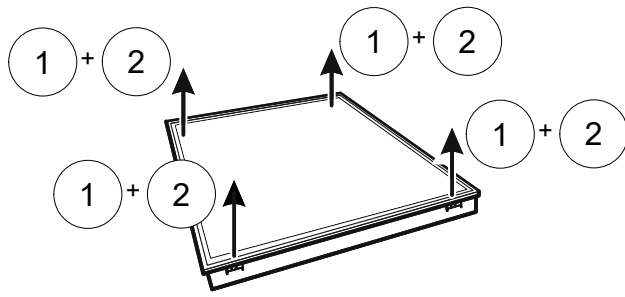

EBRE
EBRME

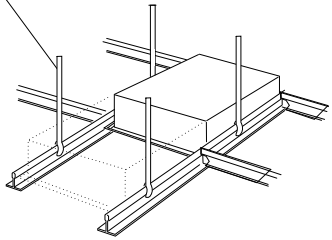
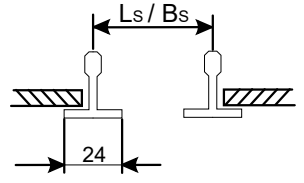
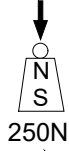
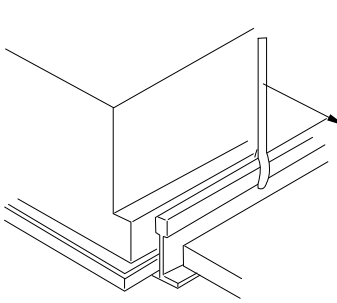
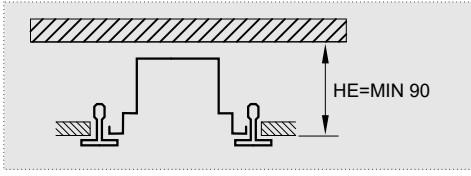

3/11



← Ls / Bs

EBRE
EBRME

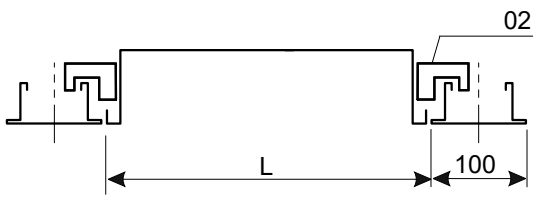
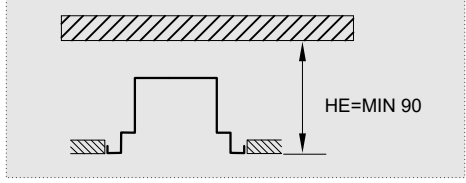

0210127

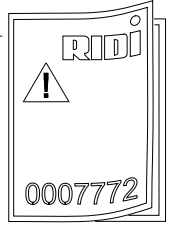

3/11



← L

EBRE
EBRME

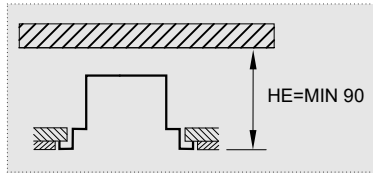

3/11



Le / Be

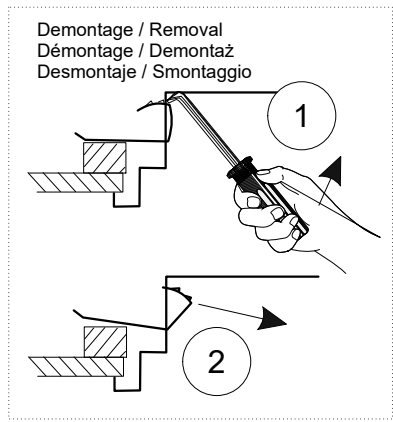
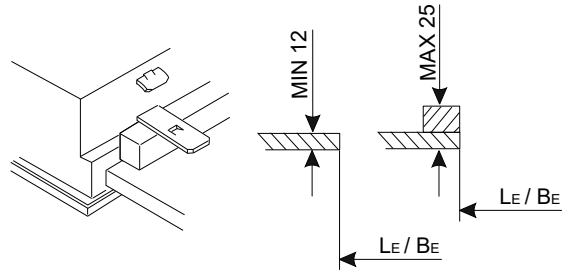
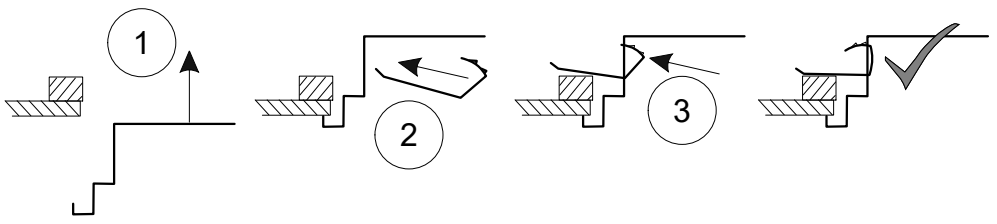

EBRE
EBRME

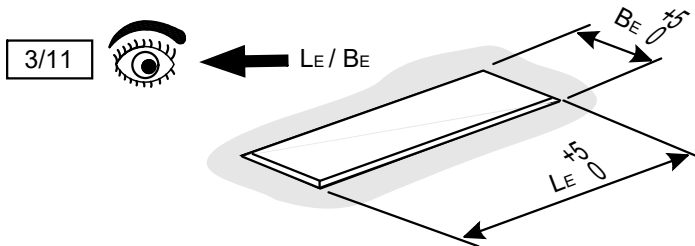
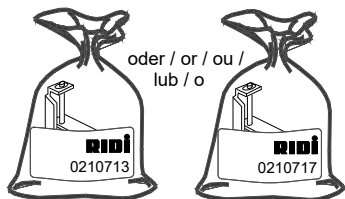
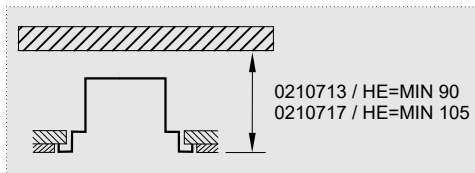

0210713 $\hat{=}$ H_k MIN 23 MAX 55
0210717 $\hat{=}$ H_k MIN 45 MAX 80

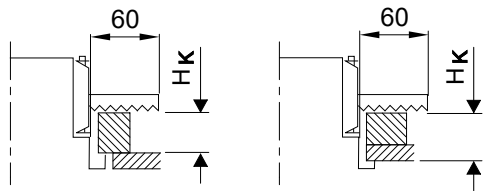
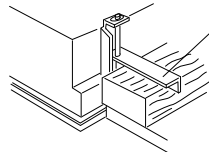

EBRE
EBRME

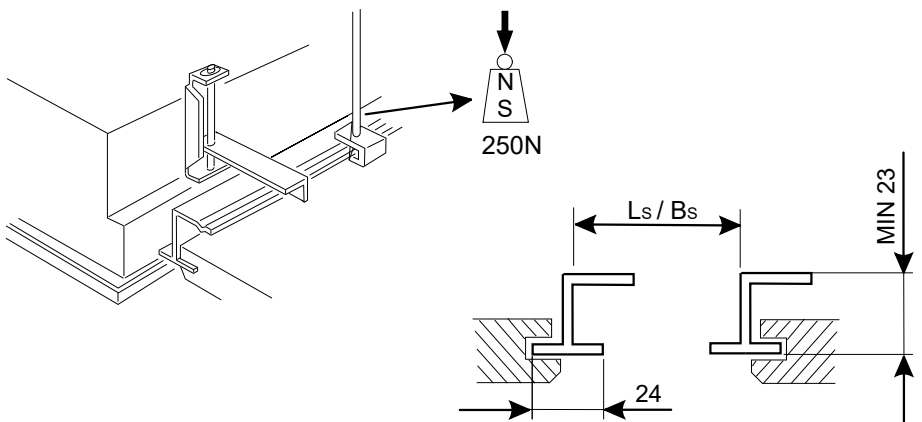
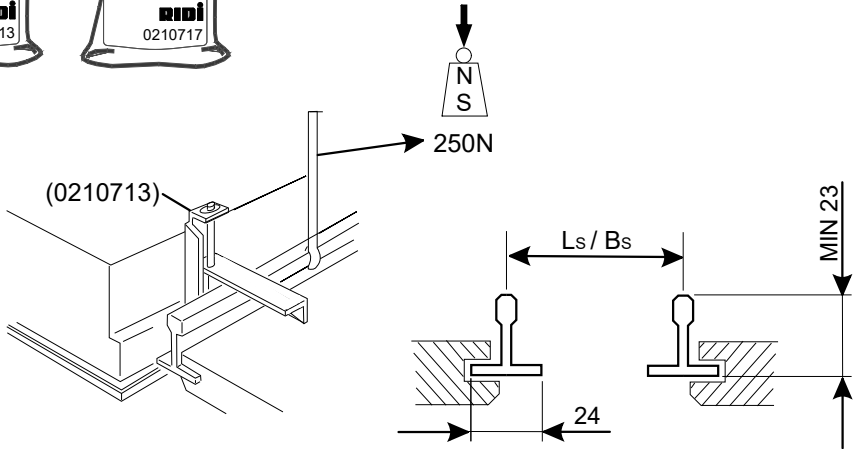
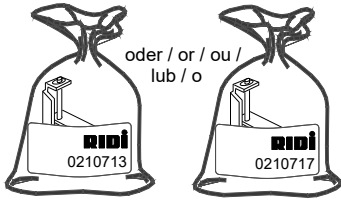
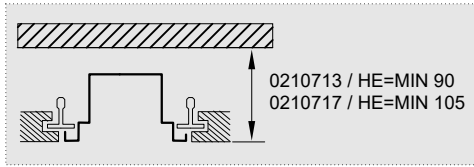

Keine Isolierung
No insulation
Pas d'isolation
Brak izolacji
Sin aislamiento
Nessun isolamento

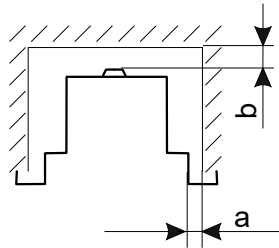
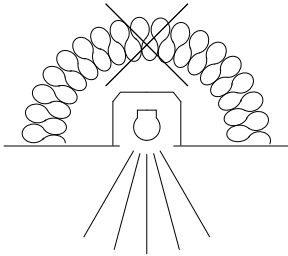

$a_{\min} = 60 \text{ mm}$

$b_{\min} = 30 \text{ mm}$

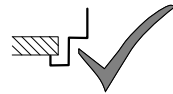
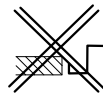
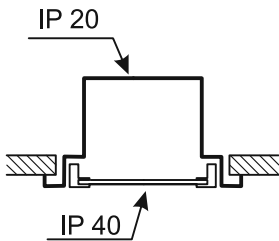

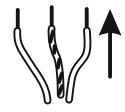
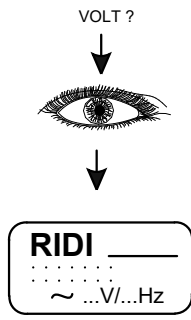
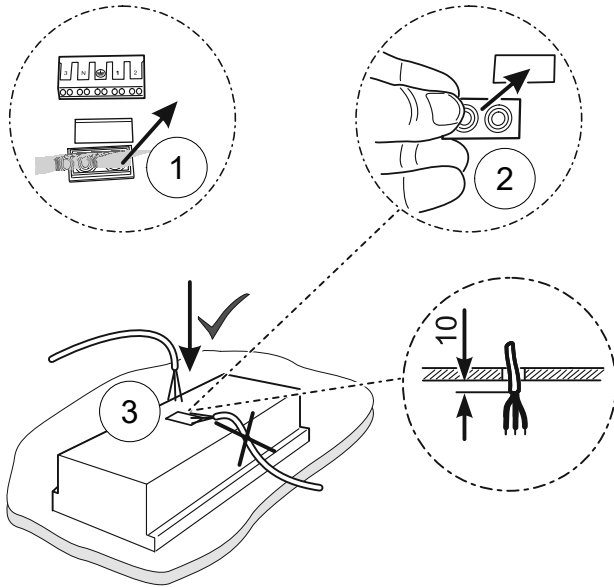

	qmm	A
	0,5-1,0	9
	sol. 1,5-2,5	12
0,5-2,5 mm ²		
	∅	A
	0,8-1,2	9
	1,3-1,8	12
max ∅1,8mm		
	∅	A
	0,8-1,2	9
	1,3-1,8	12
max ∅1,8mm		

optional

