

8 | 7 | 6 | 5 | 4 | 3 | 2 | 1

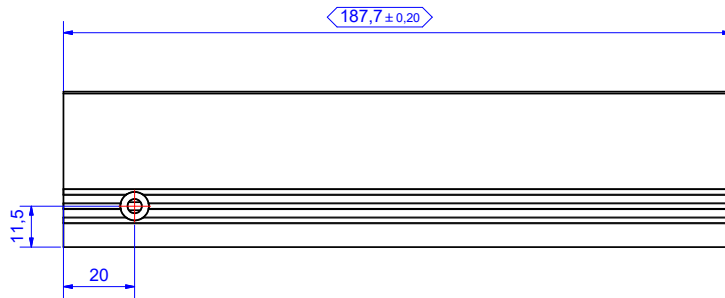

(1:1,5)

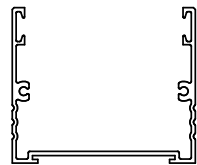
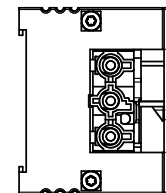
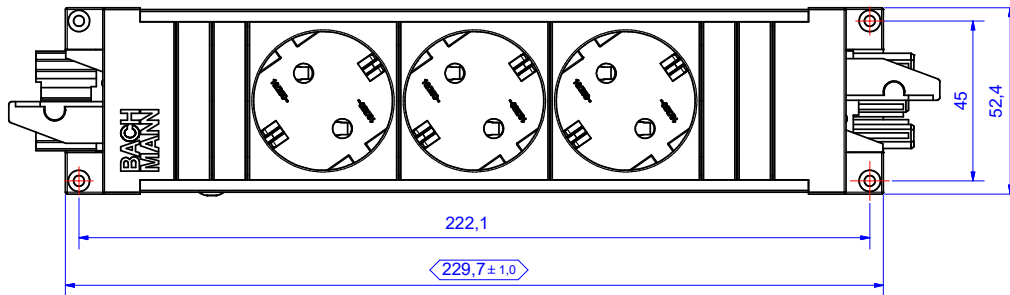
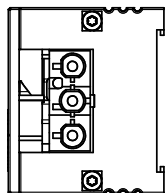
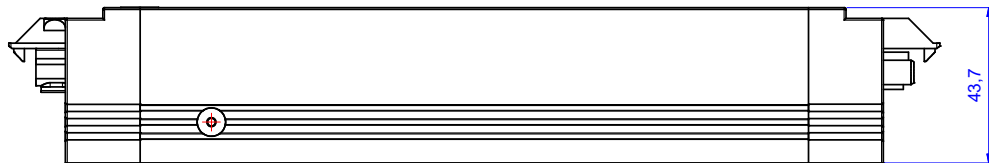
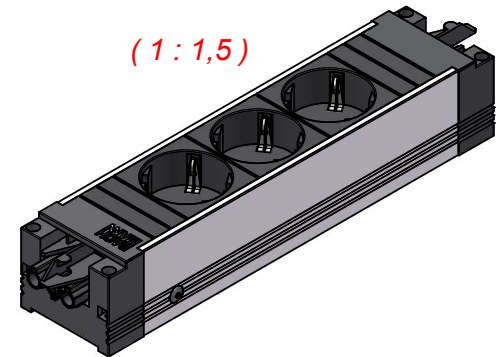

8 | 7 | 6 | 5 | 4 | 3 | 2 | 1

Werkstoff / Material:		Gewicht / Weight: <input type="checkbox"/>	Oberfläche / Siehe Einzelteile / look at the single parts Surface:
Siehe Einzelteile / look at the single parts		Bezeichnung / Title:	
Datum Name		STEP	
2022/9/19	Alan	STEP ALU 3xCEE7/3 GST18	
2022.09.19	HY	Zeichg.Nr / Draw.-No: B01792400BA04	
2022.09.19	HY	Art.Nr: 906.18815	
Maststab / Scale: 1:1		Format / Draw.-Size: A2	Blatt / Sheet: 1
Änderungen / Changes: Datum / Date Name			
<small>Wiedergabe sowie Vervielfältigung dieses Dokuments, Verwertung und Mitteilung seines Inhalts verboten, soweit nicht ausdrücklich gestattet. Zuwiderhandlungen verpflichten zu Schadenersatz. Alle Rechte für den Fall der Patent-, Gebrauchsmuster- oder Zeichnungsmusterreue vorbehalten.</small>		<small>The reproduction, distribution and utilization of this document as well as the communication of its contents to others without express authorization is prohibited. Offenders will be held liable for the payment of damages. All rights reserved in the event of the grant of a patent, utility model or design.</small>	
<small>本文未经许可不得转让及翻印，不允许引用或转载其内容，违者必究，并须赔偿损失。保留专利及商标注册的所有权。</small>			