

## Montageanleitung

Ⓒ mounting instruction Ⓕ Notice de montage Ⓒ Instrukcja montaży  
Ⓔ Instrucciones de montaje Ⓘ Istruzioni di montaggio

### ABRFB...LFA...

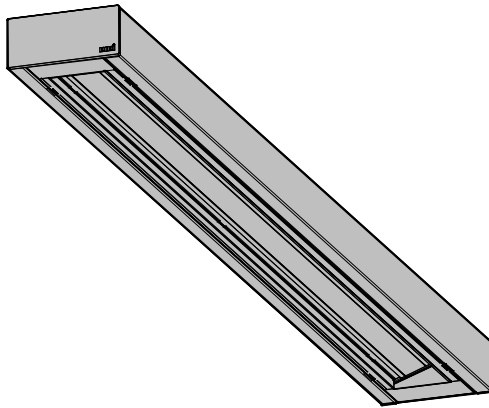

RIDI Leuchten GmbH  
Hauptstrasse 31 - 33 · D-72417 Jungingen  
Tel. 07477/872-0 · Fax 07477/872-48  
kontakt@ridi-group.de · www.ridi-group.com

RIDI Lighting Ltd  
8&9 Marshgate Centre  
Harlow Business Park  
Harlow, CM19 5QP  
01279 450882  
info@ridi.co.uk



- (D) Für die Installation und für den Betrieb der Leuchten sind die nationalen Sicherheitsvorschriften zu beachten.
- (GB) Please note national safety instructions for installation and operation of this luminaire.
- (F) Pour l'installation et le fonctionnement des luminaires il est impératif de respecter les normes nationales de sécurité en vigueur.
- (PL) W celu prawidłowej instalacji i poprawnego działania oprawy należy przestrzegać krajowych przepisów bezpieczeństwa.
- (E) Para la instalación y la puesta en funcionamiento de las luminarias deben observarse las normas nacionales de seguridad.
- (I) Per l'installazione e il funzionamento delle lampade si fa riferimento alle normative di sicurezza nazionali.

- (D) Die Lichtquelle dieser Leuchte darf nur vom Hersteller oder einem von ihm beauftragten Servicetechniker oder einer vergleichbar qualifizierten Person ersetzt werden.
- (GB) Only the manufacturer, a trained service technician or another equally qualified person is permitted to replace the light source of this luminaire.
- (F) La source lumineuse de ce luminaire ne peut être remplacée que par le fabricant, un technicien de service mandaté par celui-ci ou une personne présentant une qualification analogue.
- (PL) Wymiany źródła światła w tej oprawie oświetleniowej może dokonać wyłącznie producent bądź uprawniony pracownik serwisu albo osoba o podobnych kwalifikacjach.
- (E) La fuente de luz de esta luminaria solamente podrá ser sustituida por el fabricante o una persona designada por este, ya sea un técnico de servicio u otra persona debidamente cualificada.
- (I) La sorgente luminosa di tale lampada può essere sostituita solo dal produttore o da un tecnico di assistenza da questi designato oppure da personale dotato di qualifica equivalente.

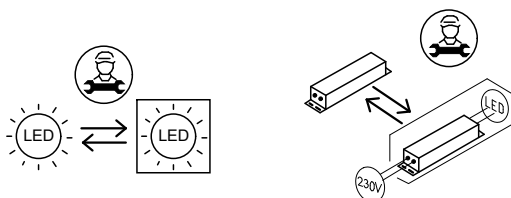
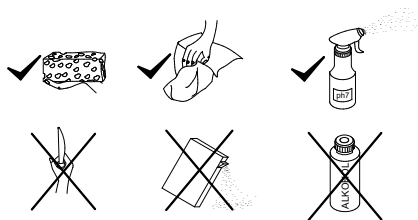

Druckfehler und Irrtum vorbehalten.  
Formelle und technische Änderungen behalten wir uns vor.

Misprints and errors excepted.  
We reserve the right of formal and technical modifications.

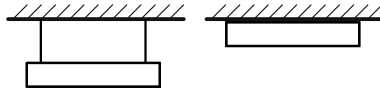
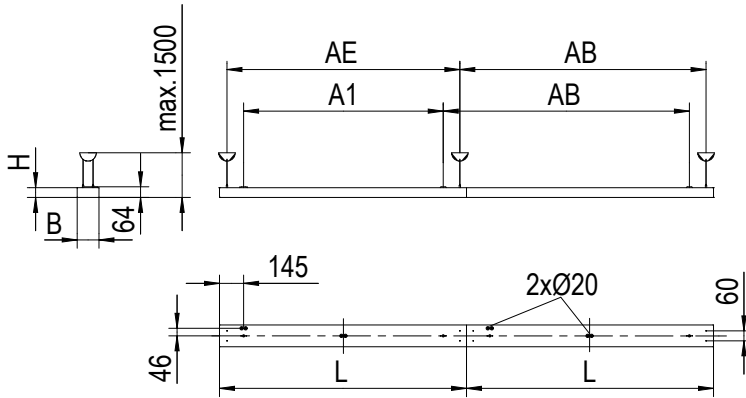
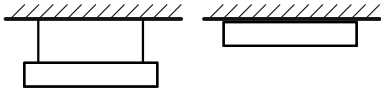

ABRFB...LFA...



Type	L	B	H	A1	AB	AE	
ABRFB1180...LFA...	1180	131	60	900	1180	1100	220
ABRFB1480...LFA...	1480	131	60	1200	1480	1400	270

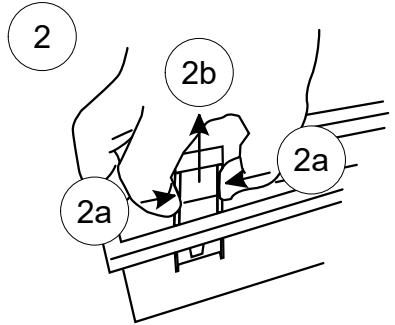
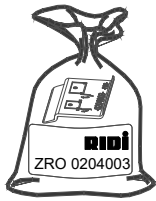
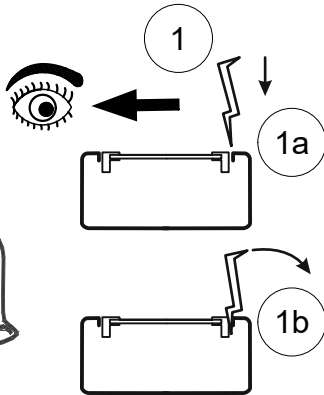
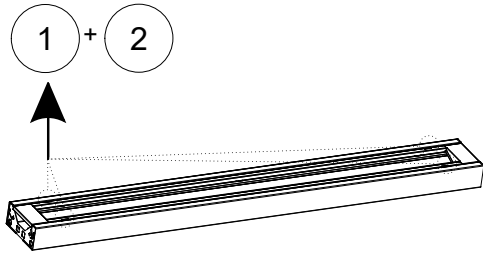

0203581 ABRFBE  
0203584 ABRFBKE

ABRFB...

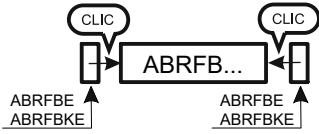

ABRFB... ABRFB...

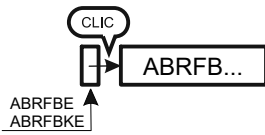

ABRFB... ABRFB...

ABRFB...

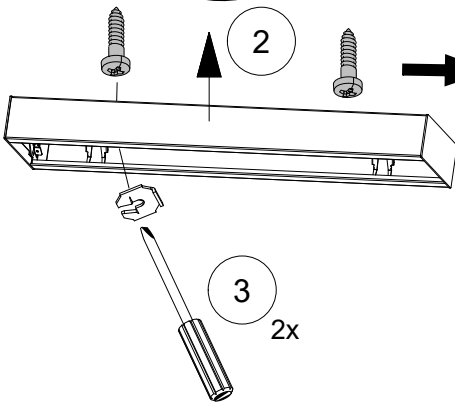
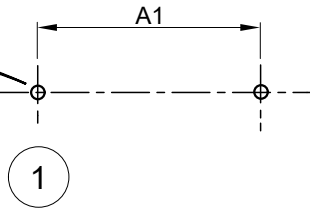
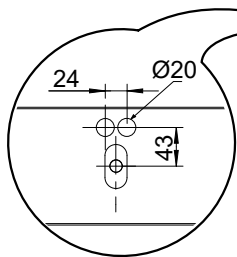
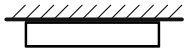

bauseits  
to be supplied on-site  
À prévoir sur place  
we własnym zakresie  
por parte del cliente  
a cura del cliente



3/8

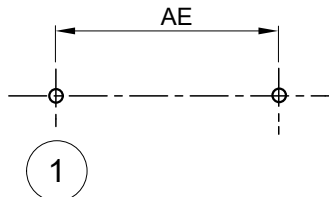
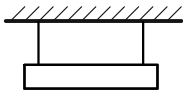

0008286



bauseits  
to be supplied on-site  
À prévoir sur place  
we własnym zakresie  
por parte del cliente  
a cura del cliente



3/8

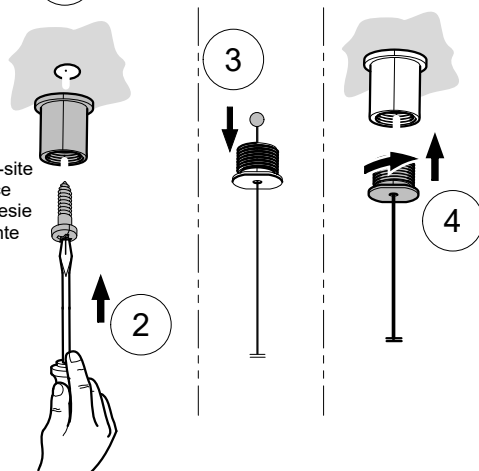



??V / ??Hz

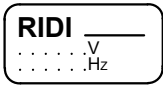

ND

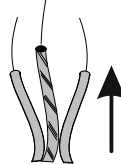
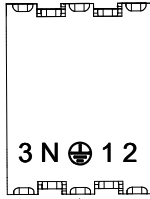

	mm	A
	0,5-1,0	9
	sol. 1,5-2,5	12
<b>0,5-2,5 mm<sup>2</sup></b>		

	ø	A
	0,8-1,2	9
	1,3-1,8	12
<b>max ø1,8mm</b>		

DALI

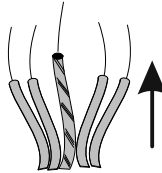

	ø	A
	0,8-1,2	9
	1,3-1,8	12
<b>max ø1,8mm</b>		

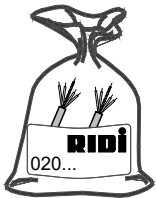

Type	Nr
ZIDV 36/3/1,5	0201201
ZIDV 36/5/1,5	0200254
ZIDV 58/3/1,5	0201202
ZIDV 58/5/1,5	0200255

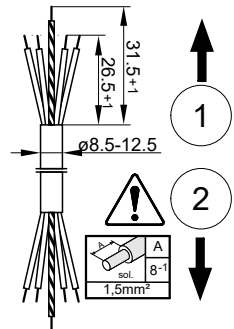
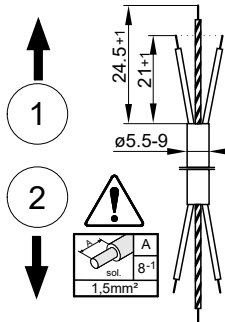

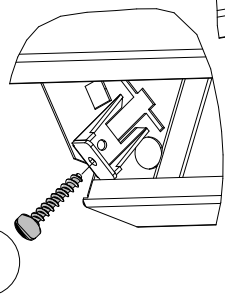
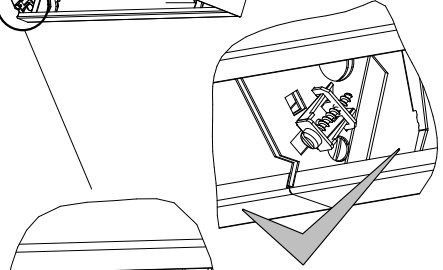
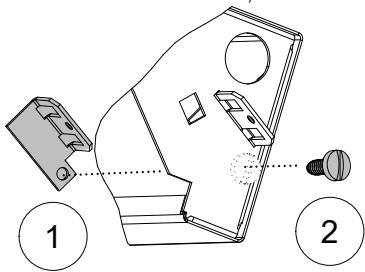
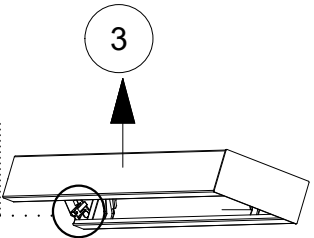
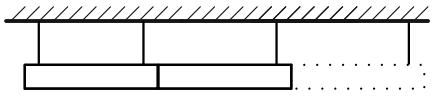
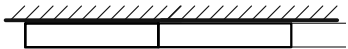

0203581 ABRFBE  
0203584 ABRFBKE

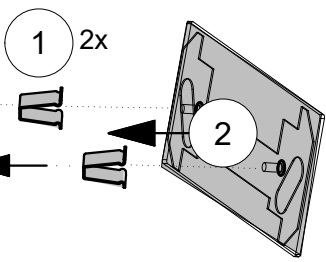
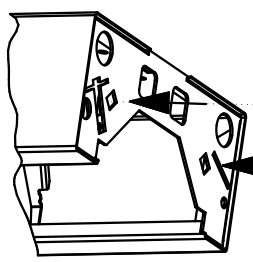

0207783 AG-ALE/ABRF 128/154  
0207784 AG-ALE/ABRF 135/149

