

Spectral[®]

Montageanleitung

Ⓒ mounting instruction Ⓕ Notice de montage Ⓖ Instrukcja montażu
Ⓔ Instrucciones de montaje Ⓘ Istruzioni di montaggio

S36-P

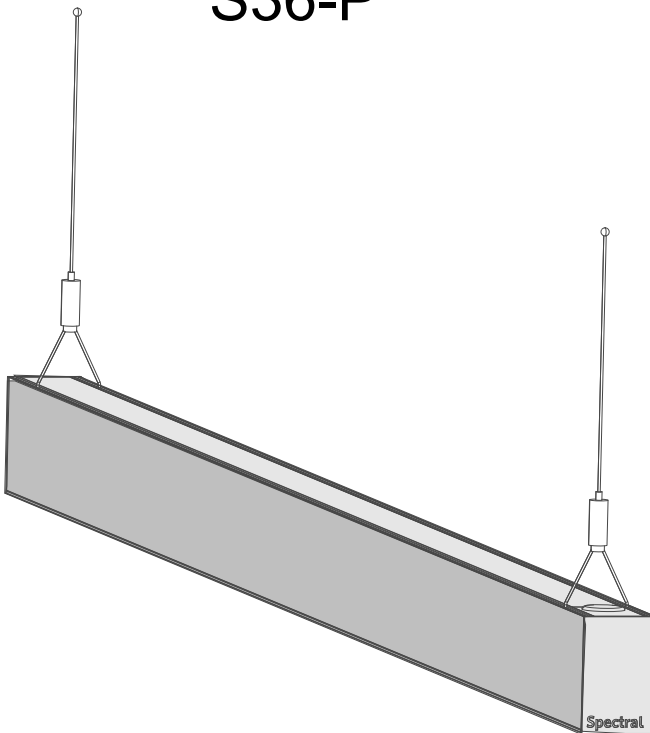

RIDI Leuchten GmbH
Hauptstrasse 31 - 33 · D-72417 Jungingen
Tel. 07477/872-0 · Fax 07477/872-48
kontakt@ridi-group.de · www.ridi-group.com



- Ⓓ Für die Installation und für den Betrieb der Leuchten sind die nationalen Sicherheitsvorschriften zu beachten.
- ⒼⒹ Please note national safety instructions for installation and operation of this luminaire.
- Ⓕ Pour l'installation et le fonctionnement des luminaires il est impératif de respecter les normes nationales de sécurité en vigueur.
- ⒼⓁ W celu prawidłowej instalacji i poprawnego działania oprawy należy przestrzegać krajowych przepisów bezpieczeństwa.
- Ⓔ Para la instalación y la puesta en funcionamiento de las luminarias deben observarse las normas nacionales de seguridad.
- Ⓘ Per l'installazione e il funzionamento delle lampade si fa riferimento alle normative di sicurezza nazionali.

Ⓓ Die Lichtquelle dieser Leuchte ist nicht ersetzbar, wenn die Lichtquelle ihr Lebensdauerende erreicht hat, ist die gesamte Leuchte zu ersetzen.



- ⒼⒹ The light source of this luminaire is not replaceable. When light source has reached end of life-time the complete luminaire has to be replaced.
- Ⓕ La source lumineuse de ce luminaire n'est pas remplaçable. Quand la source lumineuse aura atteint la limite de sa durée de vie, le luminaire complet doit être remplacé.
- ⒼⓁ Nie ma możliwości wymiany źródła światła w tej oprawie oświetleniowej, po zakończeniu żywotności źródła światła, należy wymienić całą oprawę oświetleniową.
- Ⓔ La fuente lumínica de esta luminaria no se puede sustituir. Cuando la fuente lumínica ha alcanzado el final de su vida útil, hay que sustituir toda la luminaria.
- Ⓘ La sorgente di luce di questa lampada non è sostituibile, una volta esaurita la sua durata si deve sostituire l'intera lampada.

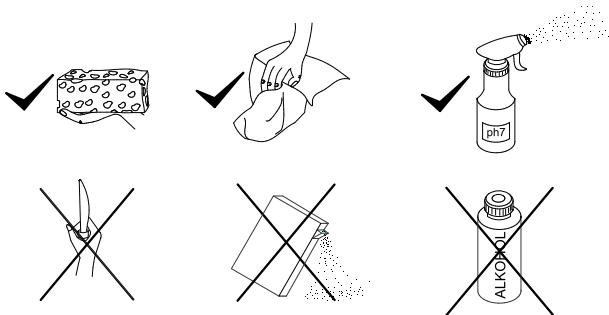

Optiken
optics
optiques
ópticas
optyka

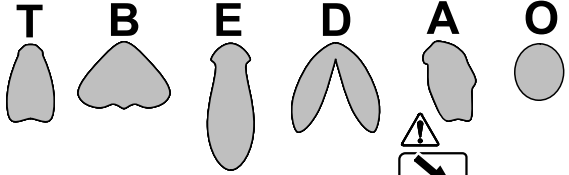
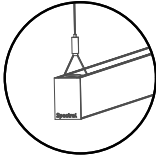

12/12

Optiken

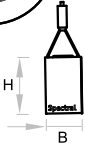
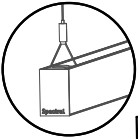

Type	L (mm)	B (mm)	H (mm)	AE (mm)		
S36 900	900	36	57	790	130	(A)
S36 1200	1200	36	57	1090	150	(A)
S36 1500	1500	36	57	1390	180	(A)
S36 1800	1800	36	57	1670	225	(A)
S36 2400	2400	36	57	2270	300	(A)
S36 3000	3000	36	57	2300	360	(A)
S36 ...	> 3000	36	57	< 2300	360	(B)+(C)

4/12



Wanne LPO

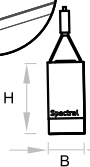
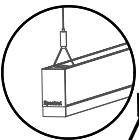

Type	L (mm)	B (mm)	H (mm)	AE (mm)		
S36 900	900	36	72	790	150	(A)
S36 1200	1200	36	72	1090	180	(A)
S36 1500	1500	36	72	1390	225	(A)
S36 1800	1800	36	72	1670	300	(A)
S36 2400	2400	36	72	2270	360	(A)
S36 3000	3000	36	72	2300	360	(A)
S36 ...	> 3000	36	72	< 2300	360	(B)+(C)

* = 

(A)

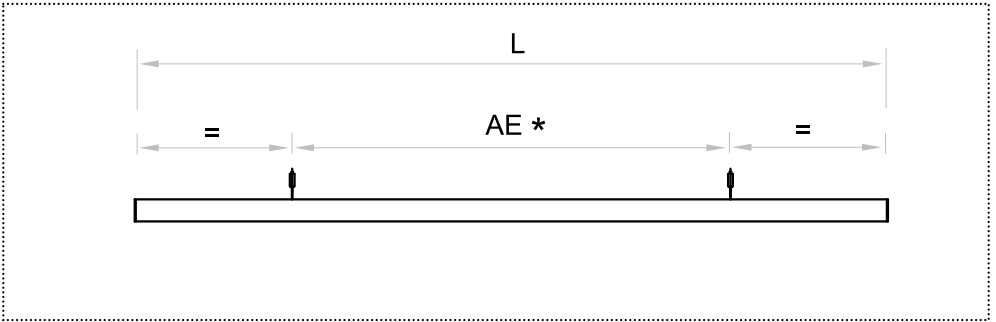

(B)

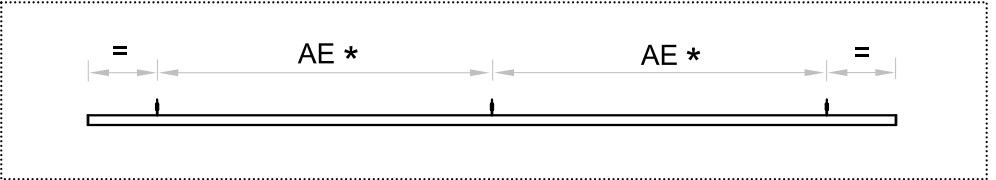

(C)

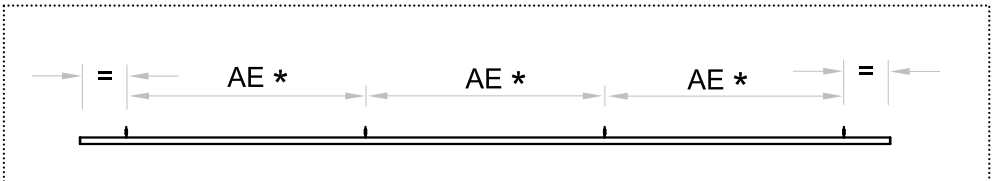

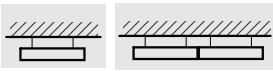

1

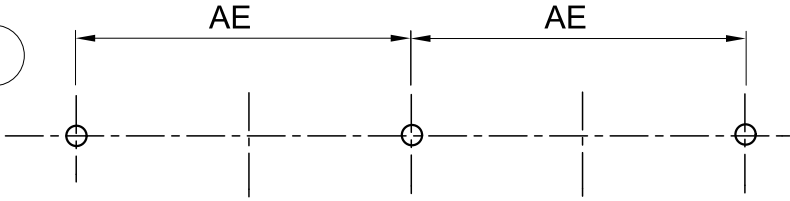

3/12

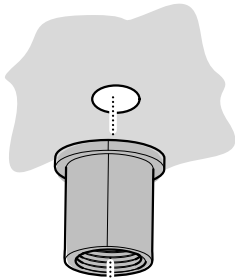
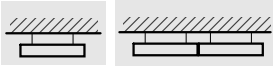

2
min. 2x

bauseits
to be supplied at site
A prévoir sur place
Prever a la red
we własnym zakresie

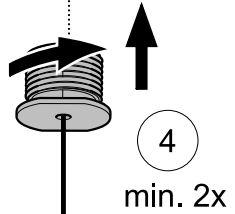
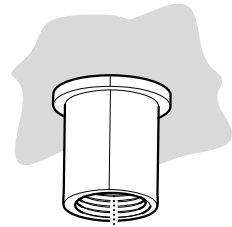
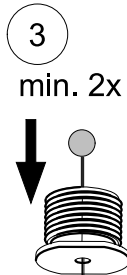

3/12

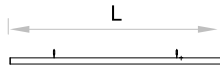
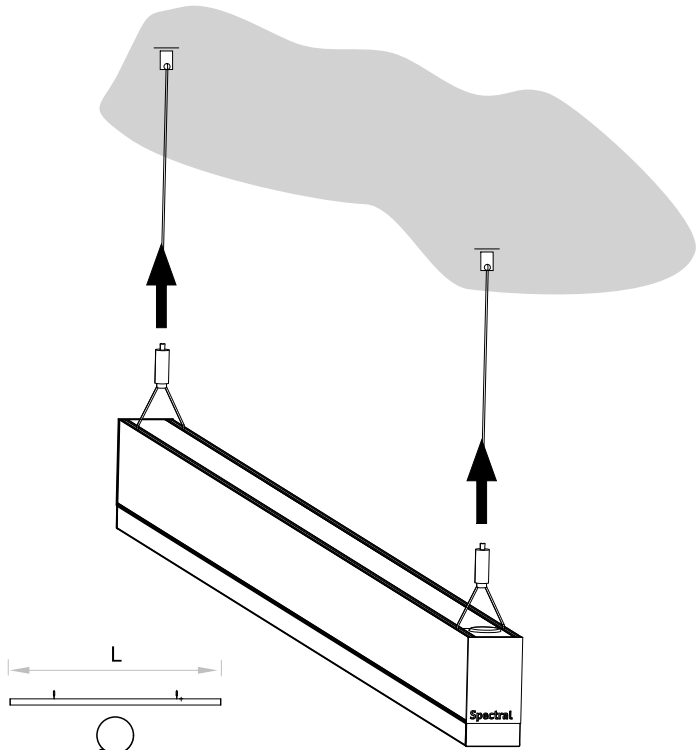
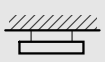

$L < 1m$



+



$L < 2m$



+



+



$L > 2m$

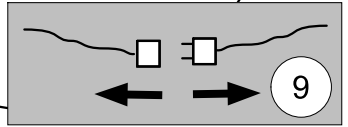
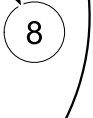
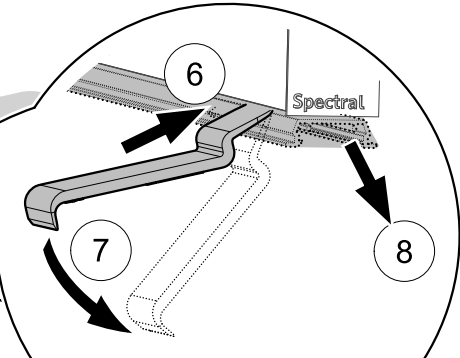
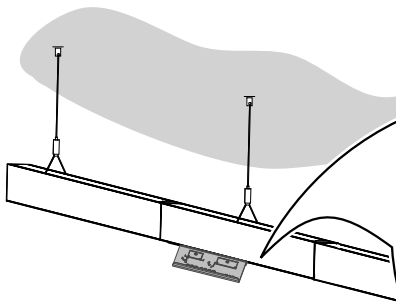
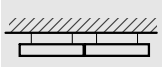
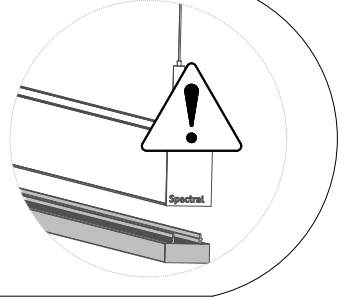
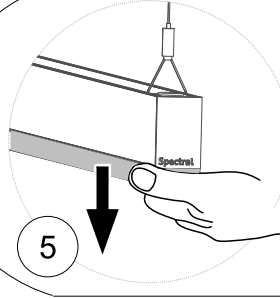
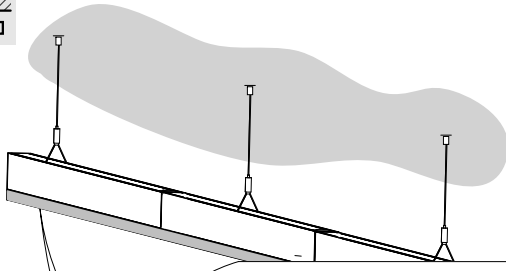
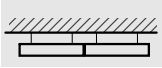

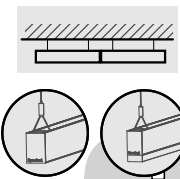
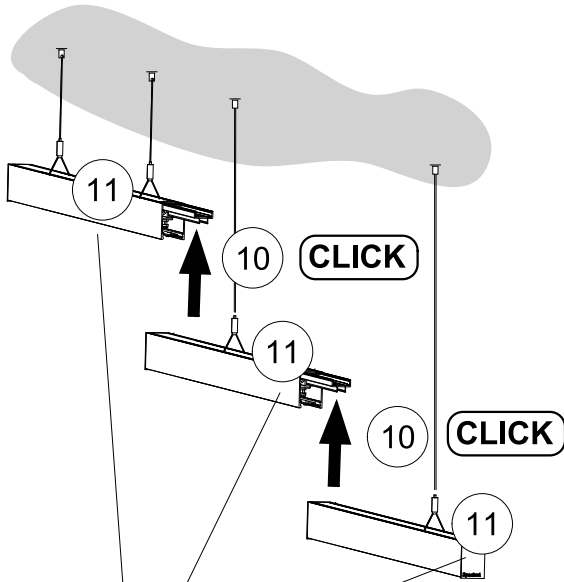
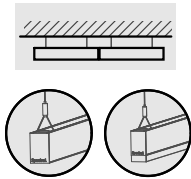

min. 2x 11

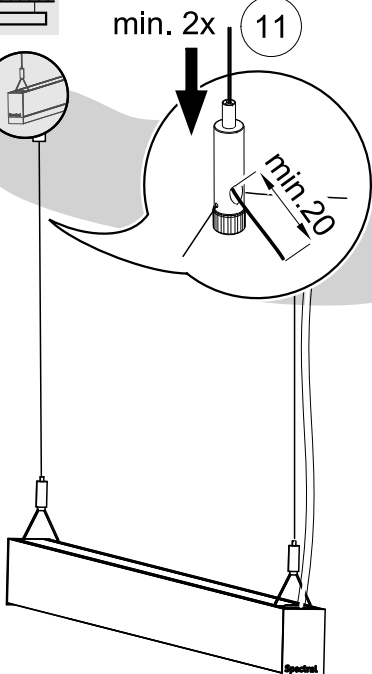

5/12

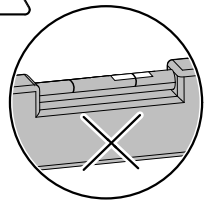
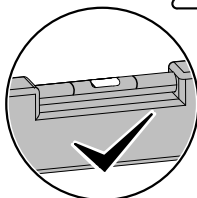
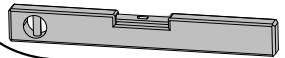
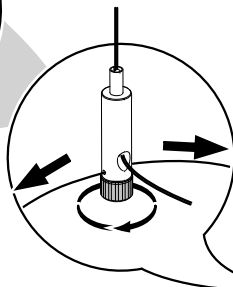
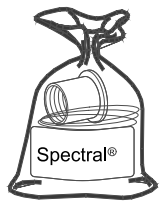

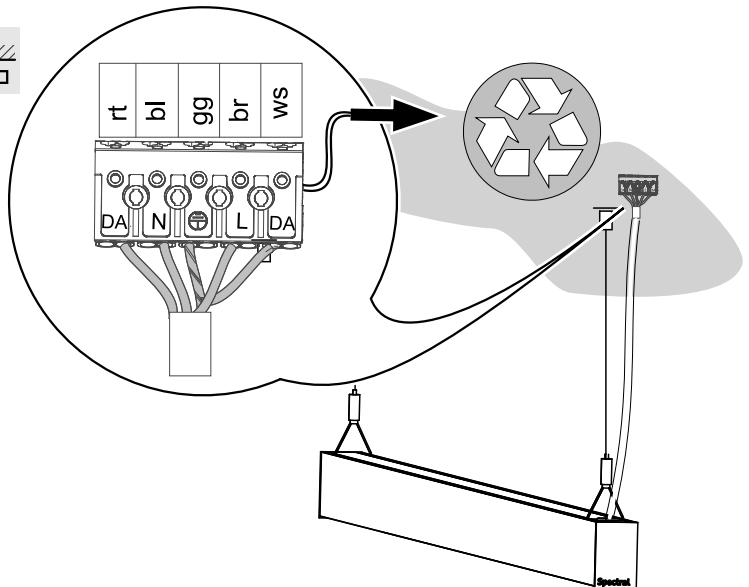
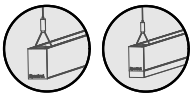
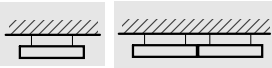
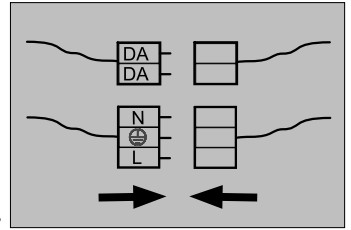
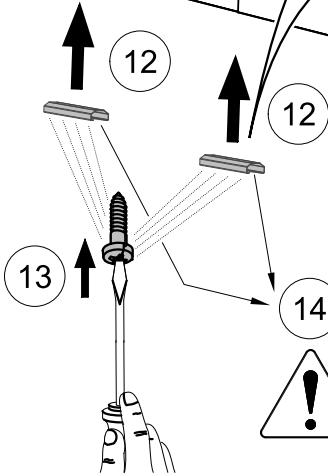
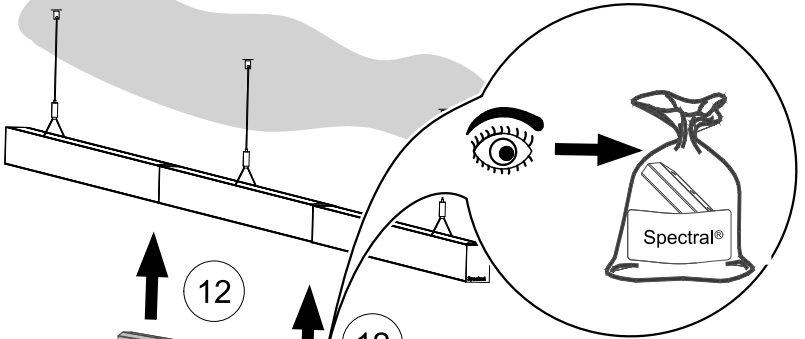
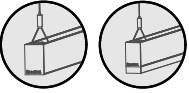
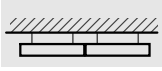

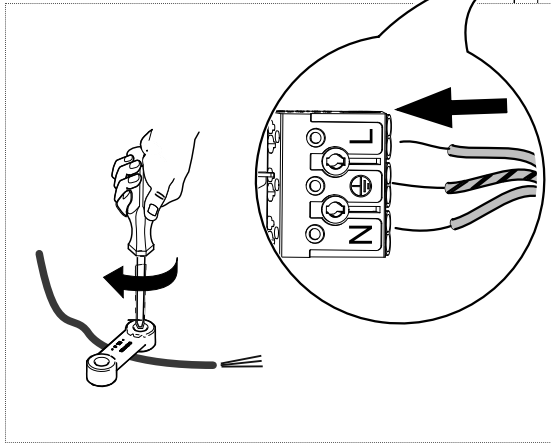
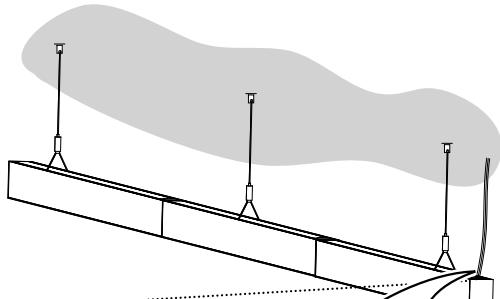
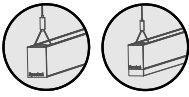
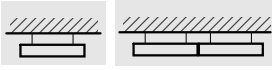

optional
optional
optionnel
opcional
Opcjonalny

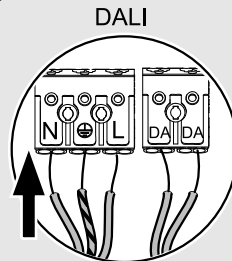
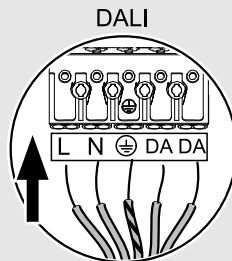

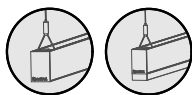
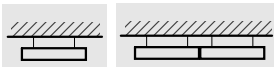

		qmm	A
sol.		0,5-1,0	9
		1,5-2,5	12
0,5-2,5 mm ²			

		Ø	A
		0,8-1,2	9
		1,3-1,8	12
max Ø1,8mm			

		Ø	A
		0,8-1,2	9
		1,3-1,8	12
max Ø1,8mm			



optional
optional
optionnel
opcional
Opcjonalny

Volt ? →

